



### Description

Silicon Carbide (SiC) MOSFET use a completely new technology that provide superior switching performance and higher reliability compared to Silicon. In addition, the low ON resistance and compact chip size ensure low capacitance and gate charge. Consequently, system benefits include highest efficiency, faster operating frequency, increased power density, reduced EMI, and reduced system size.

### Features

- High Speed Switching with Low Capacitances
- High Blocking Voltage with Low RDS(on)
- Optimized package with separate driver source pin
- Easy to parallel and simple to drive
- ROHS Compliant, Halogen free

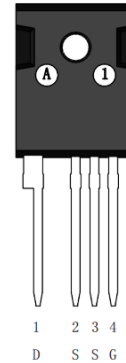

### Application

- EV Charging
- High Voltage DC/DC Converters
- Switch Mode Power Supplies
- Power Factor Correction Modules

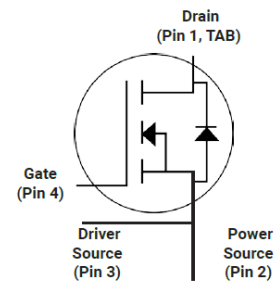

### Ordering Information

Part Number	Marking	Package	Packaging
SSC30N1200MT4	SSC30N1200MT4	TO-247	Tube

**Absolute Maximum Ratings(Tc=25°C)**

Symbol	Parameter	Value	Unit
V <sub>DS</sub>	Drain-Source Voltage	1200	V
I <sub>D</sub>	Drain Current(continuous)at Tc=25°C	32	A
I <sub>D</sub>	Drain Current(continuous)at Tc=100°C	23	A
I <sub>DM</sub>	Drain Current (pulsed)	80	A
V <sub>GS</sub>	Gate-Source Voltage	-10/+22	V
P <sub>D</sub>	Power Dissipation T <sub>C</sub> = 25°C	145	W
T <sub>J</sub> , T <sub>stg</sub>	Junction and Storage Temperature Range	-55 to +150	°C

**Electrical Characteristics(T<sub>J</sub> = 25°C unless otherwise specified)****Typical Performance-Static**

Symbol	Parameter	Test Conditions	Min.	Typ.	Max.	Unit
BV <sub>DS</sub>	Drain-source Breakdown Voltage	I <sub>D</sub> =250uA, V <sub>GS</sub> =0V	1200			V
I <sub>DSS</sub>	Zero Gate Voltage Drain Current	V <sub>DS</sub> =1200V, V <sub>GS</sub> =0V, T <sub>J</sub> =25°C			100	uA
I <sub>GSS</sub>	Gate-body Leakage Current	V <sub>DS</sub> =0V ; V <sub>GS</sub> =-10 to 20V			250	nA
V <sub>GS(th)</sub>	Gate Threshold Voltage	V <sub>DS</sub> = V <sub>GS</sub> , I <sub>D</sub> =5mA	2	3	4	V
V <sub>GS(on)</sub>	Recommended turn-on Voltage	Static		20		V
V <sub>GS(off)</sub>	Recommended turn-off Voltage			-5		V
R <sub>DS(on)</sub>	Static Drain-source On Resistance	V <sub>GS</sub> =20V, I <sub>D</sub> =20A		80	100	mΩ
		V <sub>GS</sub> =20V, I <sub>D</sub> =20A T <sub>J</sub> =150°C		122		mΩ

**Typical Performance-Dynamic**

Symbol	Parameter	Test Conditions	Min.	Typ.	Max.	Unit
C <sub>iss</sub>	Input Capacitance	V <sub>DS</sub> =1000V, f=1MHz, V <sub>AC</sub> =25mV		1590		pF
C <sub>oss</sub>	Output Capacitance			63		pF
C <sub>rss</sub>	Reverse Transfer Capacitance			3.9		pF
g <sub>fs</sub>	Transconductance	V <sub>DS</sub> =20V, I <sub>D</sub> =20A		12		S
E <sub>oss</sub>	Coss Stored Energy	V <sub>DS</sub> =1000V, f=1MHz		35.7		μJ
E <sub>ON</sub>	Turn-On Energy (Body Diode)	V <sub>DS</sub> =800V, V <sub>GS</sub> =-5/20V, I <sub>D</sub> =20A, L=150μH T <sub>J</sub> =150°C		455		μJ
E <sub>OFF</sub>	Turn-Off Energy (Body Diode)			111		μJ
Q <sub>g</sub>	Total Gate Charge	V <sub>DS</sub> =800V, V <sub>GS</sub> =-5V/20V, I <sub>D</sub> =15A		72		nC
Q <sub>gs</sub>	Gate-source Charge			21		nC
Q <sub>gd</sub>	Gate-Drain Charge			22		nC
R <sub>G(int)</sub>	Internal Gate Resistance	f=1MHz, V <sub>AC</sub> =25mV		3		Ω
t <sub>d(on)</sub>	Turn-on Delay Time	V <sub>DS</sub> =800V, V <sub>GS</sub> =-5V/20V, I <sub>D</sub> =20A, L=150 μ H R <sub>ext</sub> =2.5Ω		42		ns
t <sub>r</sub>	Rise Time			15		ns
t <sub>d(off)</sub>	Turn-off Delay Time			36		ns
t <sub>f</sub>	Fall Time			11		ns

**Typical Performance-Reverse Diode(T<sub>J</sub> = 25°C unless otherwise specified)**

Symbol	Parameter	Test Conditions	Min.	Typ.	Max.	Unit
V <sub>FSD</sub>	Forward Voltage	V <sub>GS</sub> =0V, I <sub>F</sub> =10A, T <sub>J</sub> =25°C		4.8	6	V
		V <sub>GS</sub> =0V, I <sub>F</sub> =10A, T <sub>J</sub> =150°C		4.2	6	V
I <sub>S</sub>	Continuous Diode Forward Current	V <sub>GS</sub> =0V, T <sub>C</sub> =25°C		27		A
t <sub>rr</sub>	Reverse Recovery Time	V <sub>GS</sub> =-5 V, I <sub>F</sub> =20A, V <sub>R</sub> =800 V, di/dt=900 A/μs, T <sub>J</sub> =150°C		36		nS
Q <sub>rr</sub>	Reverse Recovery Charge			297		nC
I <sub>rrm</sub>	Peak Reverse Recovery Current			15.5		A

**Thermal Characteristics**

Symbol	Parameter	Value.	Unit
R <sub>θJC</sub>	Thermal Resistance, Junction-to-Case	0.86	°C/W
R <sub>θJA</sub>	Thermal Resistance, Junction-to-Ambient	40	°C/W

The values are based on the junction-to case thermal impedance which is measured with the device mounted to a large heat sink assuming maximum junction temperature of T<sub>J</sub>(max)=150°C

Electrical Characteristics

Fig1. Output characteristics ( $T_J = 25\text{ }^\circ\text{C}$ )

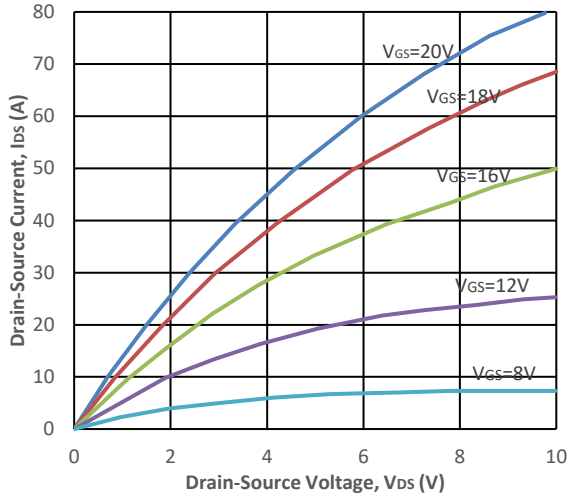

Fig2. Output characteristics ( $T_J = 150\text{ }^\circ\text{C}$ )

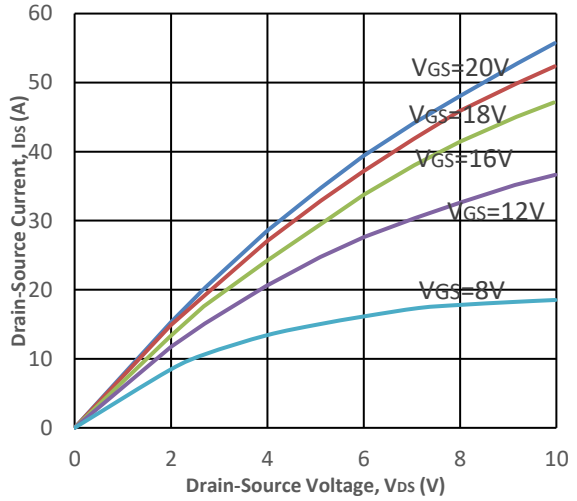

Fig3. Normalized On-Resistance vs. Temperature

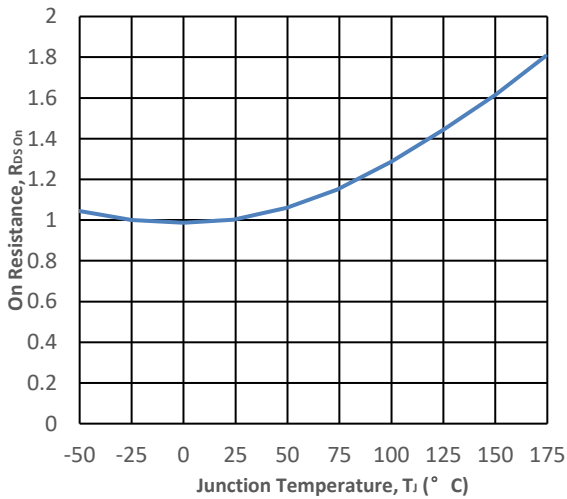

Fig4. On-Resistance vs. Temperature

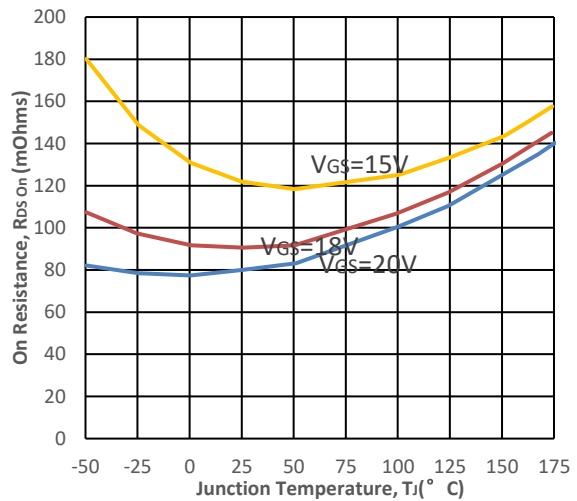

Fig5. Transfer Characteristic

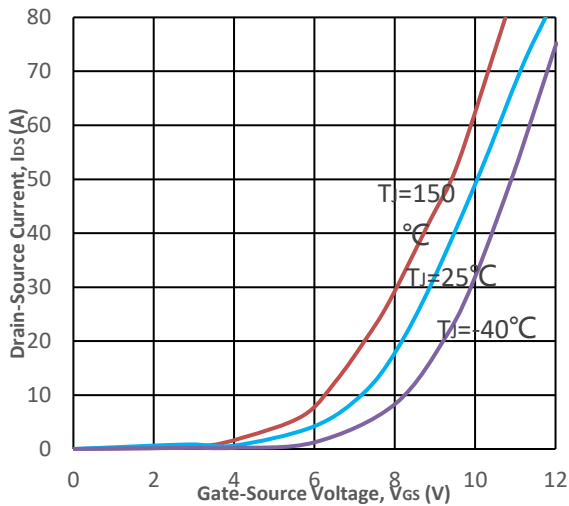
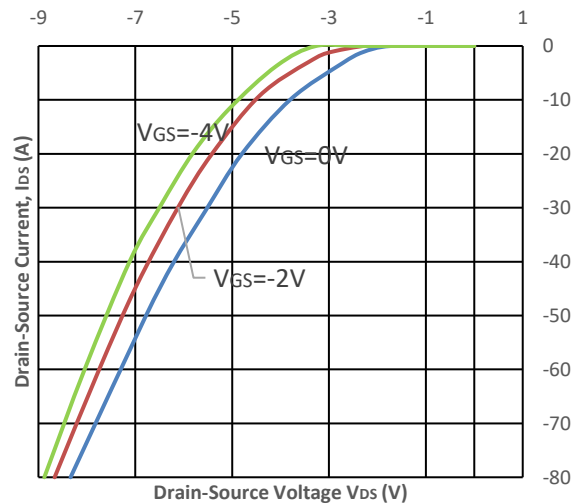
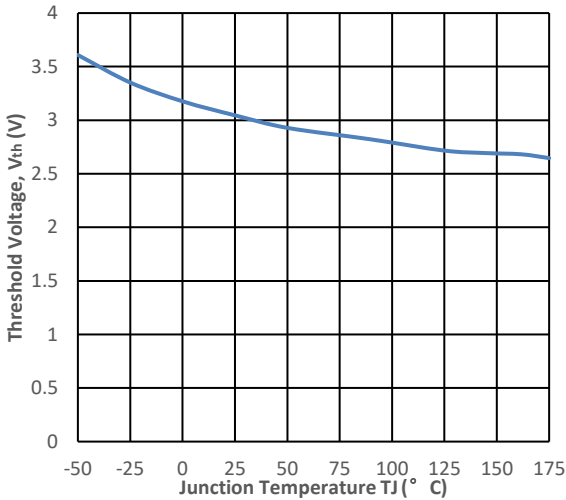

Fig6. Body Diode Characteristic at 25 °C



**Fig7. Threshold Voltage vs. Temperature**



**Fig8. Gate Charge Characteristics**

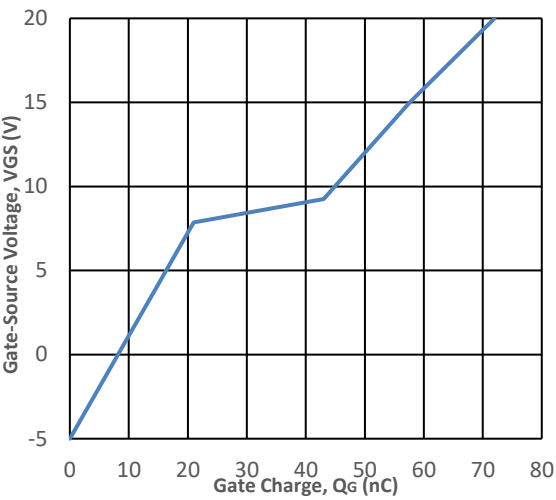

**Fig9. 3rd Quadrant Characteristic at 25 °C**

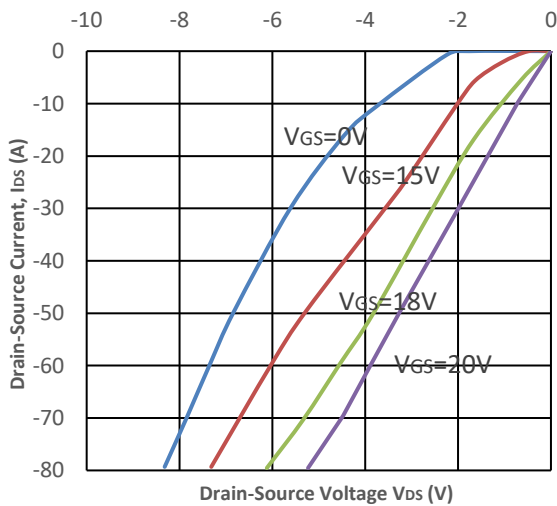

**Fig10. Output Capacitor Stored Energy**

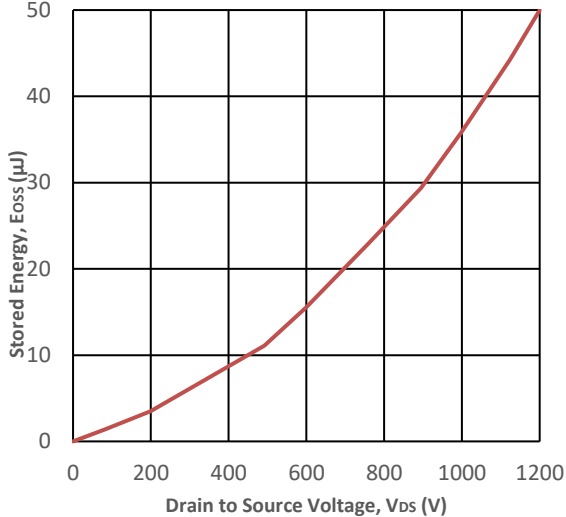

**Fig11. Capacitances vs. Drain-Source**

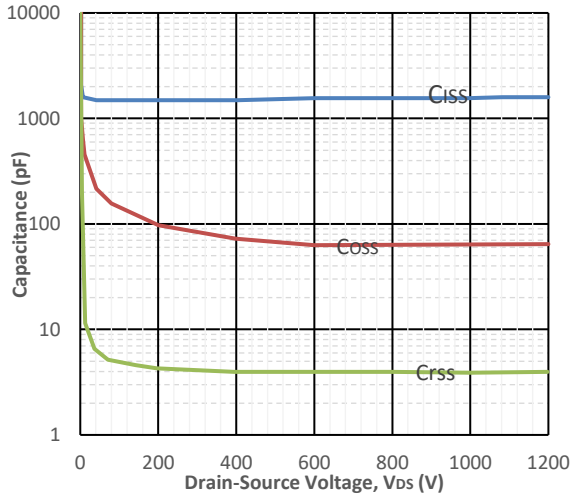

**Fig12. Max Power Dissipation Derating Vs Tc**

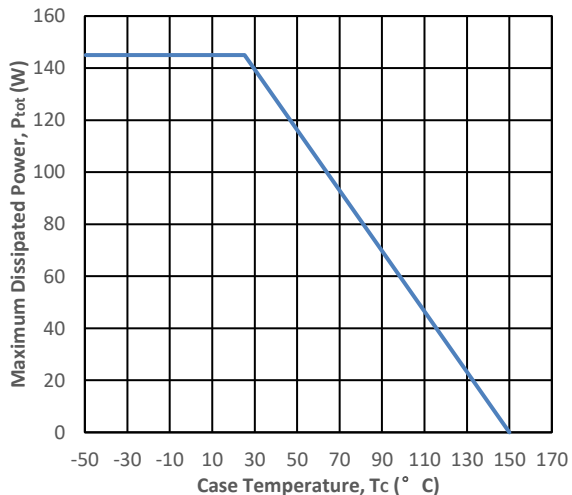

Fig13. Switching Energy vs. Drain Current

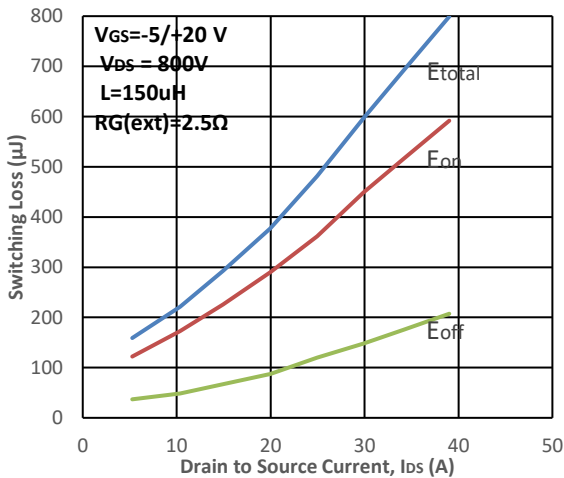

Fig14. Switching Energy vs. RG(ext)

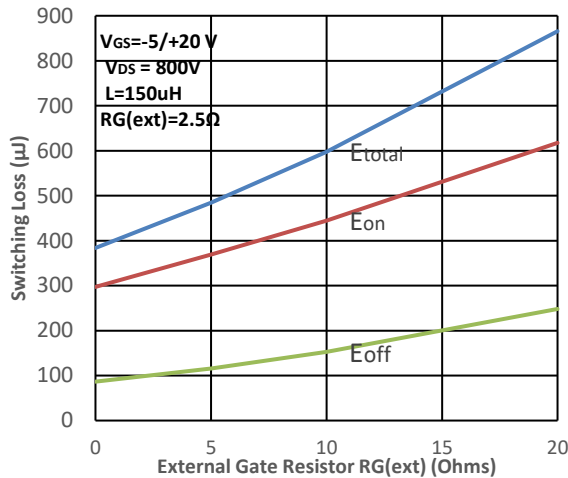

Fig15. Switching Energy vs. Temperature

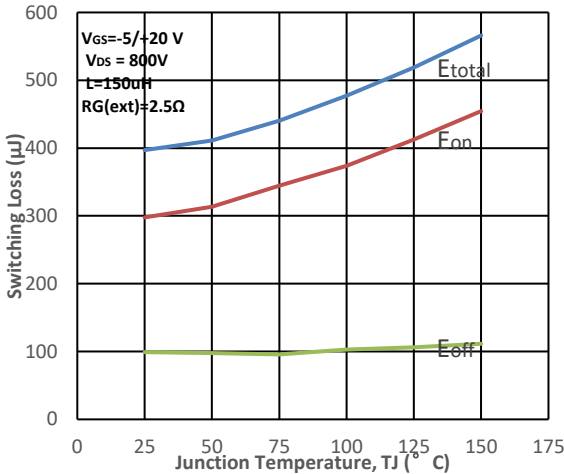

Fig16. Switching Times vs. RG(ext)

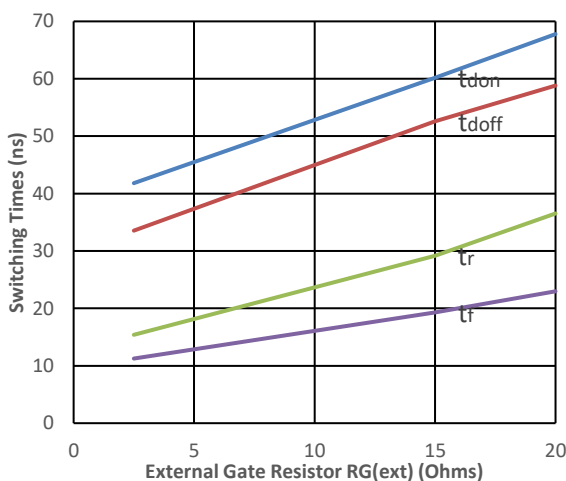

Fig17. Transient Thermal Impedance

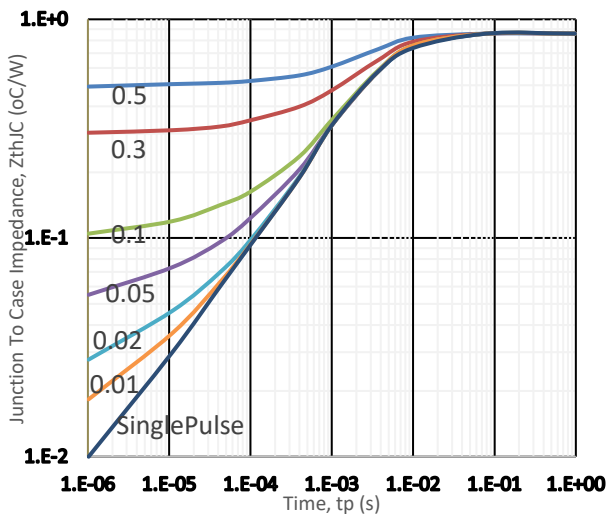
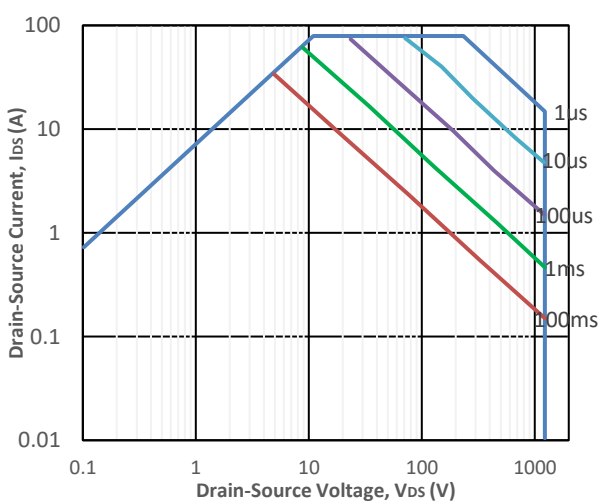
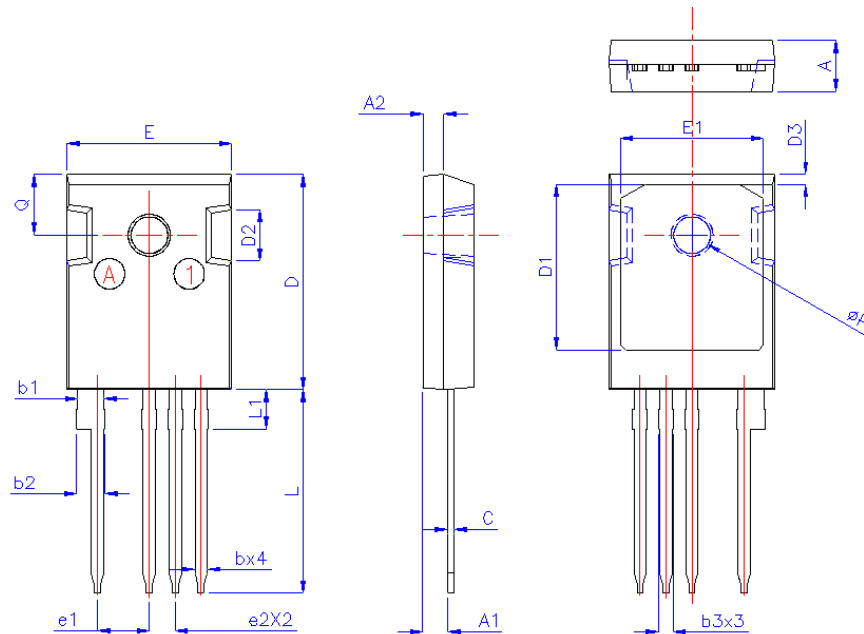

Fig18. Safe Operating Area



## Package Drawing:



## Dimensions ( UNIT: mm )

SYMBDLS	DIMENSIONS IN MILLIMETERS			DIMENSIONS IN INCHES		
	MIN	NOM	MAX	MIN	NOM	MAX
A	4.9	5	5.1	0.193	0.197	0.201
A1	2.31	2.42	2.52	0.091	0.095	0.099
A2	1.9	2	2.1	0.075	0.079	0.083
b	1.16	1.22	1.27	0.046	0.048	0.050
b1	1.15	1.2	1.25	0.045	0.047	0.049
b2	2.61	2.76	2.91	0.103	0.109	0.115
b3	1.36	1.42	1.47	0.054	0.056	0.058
C	0.59	0.62	0.66	0.023	0.024	0.026
D	20.9	21	21.1	0.823	0.827	0.831
D1	15.94	16.24	16.54	0.628	0.639	0.651
D2		5		0.197 TYP		
D3	0.8	0.95	1.1	0.031	0.037	0.043
e	5.08 BSC			0.200 BSC		
e1	2.54 BSC			0.100BSC		
E	16.05	16.15	16.25	0.632	0.636	0.640
E1	13.82	14.02	14.26	0.544	0.552	0.561
L	19.75	19.95	20.15	0.778	0.785	0.793
L1	—	—	3.87	—	—	0.152
Q	5.95 BSC			0.234BSC		
ØP	3.45	3.6	3.75	0.136	0.142	0.148